

**Type 2104**  
Pneumatically operated diaphragm valve with ELEMENT actuator



**T-diaphragm valve with pneumatic actuator in stainless steel (Type ELEMENT) for decentralised automation**

- Valve housing and diaphragm available in various materials and designs
- Surfaces in contact with the product from Ra ≤ 0.38 µm...1.6 µm (optionally electropolished)
- Available in all common connection sizes and variants

Product variants described in the data sheet may differ from the product presentation and description.

**Can be combined with**

	<b>Type 2034</b> ▶ Multifunction block and weld solution
	<b>Type 8691</b> ▶ Control head for decentralised automation of ELEMENT process valves
	<b>Type 8695</b> ▶ Control head for decentralised automation of ELEMENT process valves
	<b>Type 8692</b> ▶ Digital electropneumatic Positioner for the integrated mounting on process control valves
	<b>Type 8696</b> ▶ Digital electropneumatic positioner for the integrated mounting on process control valves
	<b>Type 8098</b> ▶ FLOWave SAW flow-meter

**Type description**

The externally controlled diaphragm valve type 2104 consists of a pneumatically operated piston actuator, a diaphragm and a T - valve housing. The proven and robust actuator with stainless steel housing ensures use under hygienic or aggressive environmental conditions. The flow-efficient valve housing with little dead space enable high flow rates and a wide range of possible uses. The valve housing and the diaphragm are available in all common materials and designs. The actuator has a compact, autoclavable design with a large stainless steel shell and gap-free seals. The integration of automation units of the ELEMENT type is possible in all expansion stages (can be retrofitted) and can be fitted with an integrated fieldbus interface. An explosion-proof ATEX/IECEX device variant is available.

It is a compact, smooth-surfaced and highly integrated system consisting of a valve and an automation unit with integrated control air ducts (no intake of ambient air). The add-on housing is optionally available in plastic or stainless steel (rotatable 360°). The valve is protected in accordance with protection classes IP65/67 and NEMA Type 4X and has a high level of chemical resistance.

DTS 1000450599 EN Version: A Status: RL (released | freigegeben | validé) printed: 10.02.2021

## Table of contents

<b>1. General technical data</b>	<b>3</b>
<b>2. Approvals</b>	<b>4</b>
<b>3. Materials</b>	<b>5</b>
3.1. Chemical Resistance Chart – Bürkert resistApp.....	5
3.2. Material specifications.....	5
3.3. Example of available membrane materials.....	6
<b>4. Dimensions</b>	<b>6</b>
4.1. Actuator.....	6
ELEMENT actuator.....	6
4.2. T-Body with welded connection.....	7
4.3. T-Body with Clamp-connection.....	11
<b>5. Performance specifications</b>	<b>12</b>
5.1. Medium pressure.....	12
<b>6. Product accessories</b>	<b>13</b>
<b>7. Networking and combination with other Bürkert products</b>	<b>18</b>
7.1. Possible combinations for ELEMENT control valve system Type 8802-TB with TopControl.....	18
7.2. Possible combinations for control valve system ELEMENT Type 8802-TB with SideControl Remote.....	19
7.3. Possible combinations for ELEMENT control valve system Type 8801-TB with control head or pneumatic control unit/position feedback.....	20
<b>8. Ordering information</b>	<b>21</b>
8.1. Bürkert eShop – Easy ordering and quick delivery.....	21
8.2. Bürkert product filter.....	21
8.3. Bürkert product enquiry form.....	21

## 1. General technical data

Product properties	
Dimensions	Detailed information can be found in chapter <b>"4. Dimensions"</b> on page 6.
<b>Material<sup>1.)</sup></b>	
Block body (VH) <sup>1.)</sup>	Stainless steel 1.4435/316 L
Block body (VI) <sup>1.)</sup>	Stainless steel 1.4435/BN2/ASME BPE; Fe <0.5 %/C ≤0.03 %
Diaphragm	EPDM (AD) <sup>1.)</sup> , PTFE/EPDM (EA) <sup>1.)</sup> , advanced PTFE/EPDM (EU) <sup>1.)</sup> , Gylon®/EPDM laminated (ER) <sup>1.)</sup>
Actuator/Cover	PPS/Stainless steel 1.4561 (316Ti)
Diaphragm size	8...65
<b>Standard surface quality<sup>2.)</sup></b>	
Block body (VH/VI) <sup>1.)</sup>	Internal electrically polished : Ra ≤0.38 µm (NO17) <sup>1.)</sup> (ASME BPE SF4/DIN HE4) (external Ra ≤ 1.6 µm) Internal mechanically polished : Ra ≤0.5 µm (NO14) <sup>1.)</sup> (ASME BPE SF1) (external Ra ≤ 1.6 µm)
Performance data	
Max. pilot pressure (SF: A)	10 bar 7 bar for actuator size 130 See <b>"5.1. Medium pressure"</b> on page 12
Pilot air ports	Push-in connector for external, Ø6 mm or ¼" (Standard); thread G ¼"
Medium data	
Medium	Neutral gases and fluids, highly purified, sterile, aggressive or abrasive medium (see <b>Resistance Chart</b> ▶)
<b>Medium temperature</b>	
EPDM (AD) <sup>1.)</sup>	- 10...+ 143 °C (steam sterilisation + 150 °C for 60 min)
PTFE/EPDM (EA) <sup>1.)</sup>	- 10...+ 130 °C (steam sterilisation + 140 °C for 60 min)
Advanced PTFE/EPDM (EU) <sup>1.)</sup>	- 5...+ 143 °C (steam sterilisation + 150 °C for 60 min)
GYLON®/EPDM laminated (ER) <sup>1.)</sup>	- 5...+ 130 °C (steam sterilisation + 140 °C for 60 min)
Control medium	Neutral gases, air
Process/Port connection & communication	
Nominal diameter	DN06...DN100 (⅛"... 4")
<b>Port connections<sup>2.)</sup></b>	
Welded connection <sup>2.)</sup>	DIN EN ISO 1127/ISO 4200/DIN 11866 series B DIN 11850 series 2/DIN 11866 series A/DIN EN 10357 series A ASME BPE/DIN 11866 series C
Clamp connection <sup>2.)</sup>	DIN 32676 series A (DIN pipe) DIN 32676 series B (ISO pipe) ASME BPE
Environment and installation	
Installation position/Installation	See <b>operating manual</b> ▶
Ambient temperature	- 10...+ 60 C

1.) This information is part of the product key (see product enquiry form at the end of this data sheet)

2.) Further versions on request

## 2. Approvals

**Note:**

If you need one of these certificates, please contact your Bürkert partner.

Approvals/ Conformity/ Certificate <sup>1.)</sup>	Description
	<b>ATEX/IECEX</b> <sup>2.)</sup> EPS 18 ATEX 2 008 X II 2G Ex h IIC T4 Gb/II 2D Ex h IIIC T135 °C Db IECEX EPS 18.0007X Ex h IIC T4 Gb/Ex h IIIC T135 °C Db
<b>TA-air</b>	TA-air <sup>3.)</sup>
	3-A (3-A Sanitary Standards Symbol Administrative Council) <sup>4.)</sup>
	The diaphragms made of EPDM (AD), PTFE/EPDM (EA), advanced PTFE/EPDM (EU) and GYLON®/EPDM laminated (ER) are suitable for use with food and beverages (acc. to EC Regulation 1935/2004/EC).
	Diaphragms made of EPDM (AD), PTFE/EPDM (EA), advanced PTFE/EPDM (EU) and GYLON®/EPDM laminated (ER) are acc. to USP Class VI tested.
<b>FDA</b>	Diaphragms made of EPDM (AD), PTFE/EPDM (EA), advanced PTFE/EPDM (EU) and GYLON®/EPDM laminated (ER) comply with the Code of Federal Regulations published by the FDA (Food and Drug Administration, USA).

1.) Further approvals/conformity clarification on request

2.) Only in combination with variable code «PX51» (see product enquiry form at the end of this data sheet)

3.) Only in combination with variable code «PM01» (see product enquiry form at the end of this data sheet)

4.) Only in combination with variable code «PE05» (see product enquiry form at the end of this data sheet)

### 3. Materials

#### 3.1. Chemical Resistance Chart – Bürkert resistApp

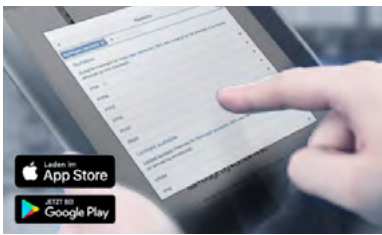

**Bürkert resistApp – Chemical Resistance Chart**

You want to ensure the reliability and durability of the materials in your individual application case? Verify your combination of media and materials on our website or in our resistApp.

[Start Chemical Resistance Check](#)

#### 3.2. Material specifications

**Note:**

Exemplary representation may differ from the actual product.

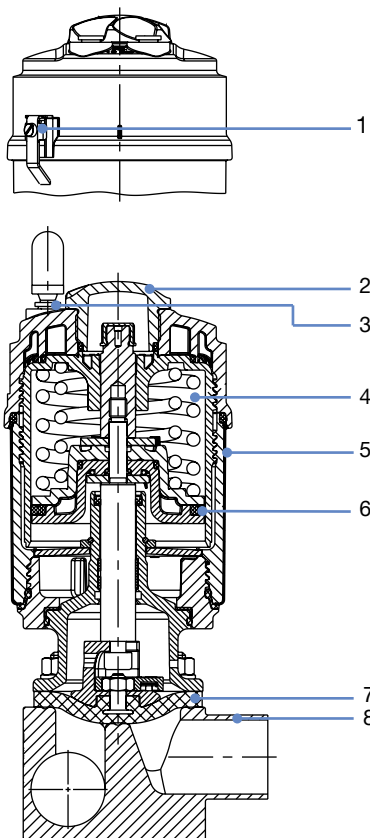

No.	Element	Material
1	Ground terminal	Stainless steel 1.4301/1.4305 (only for ATEX/IECEX version)
2	Optical position indicator	Polysulfone PSU
3	Pilot air ports	Push-in connector PP (Standard); Thread G 1/8" Stainless steel 1.4305
4	Actuator	Polyphenylene sulphide PPS
5	Cover	Stainless steel 1.4561 (316Ti)
6	Piston seal	FKM
7	Diaphragm	EPDM (AD), PTFE/EPDM (EA), advanced PTFE/EPDM (EU), Gylon®/EPDM laminated (ER)
8	Valve body	See "1. General technical data" on page 3

**Type 2104**  
**Pneumatically operated diaphragm**  
**valve with ELEMENT actuator**

**3.3. Example of available membrane materials**

The diaphragms have been developed to meet the unique challenges of hygienic and sterile requirements. Bürkert offers diaphragms with precise material composition and high accuracy. Bürkert diaphragms are available in a wide range of materials which have been tested and proven in applications in the food and beverage, biotechnology, pharmaceutical and cosmetics industries. The diaphragms are tested during development and production to ensure reliability under difficult process conditions.



- EPDM (AD)
- PTFE/EPDM (EA)
- advanced PTFE/EPDM (EU)
- Gylon®/EPDM laminated (ER)

For further information please refer to our flyer “Diaphragm competence for hygienic applications” on our [website](#) ▶.

**4. Dimensions**

**4.1. Actuator**

**ELEMENT actuator**

**Note:**  
 Dimensions in mm, unless otherwise stated

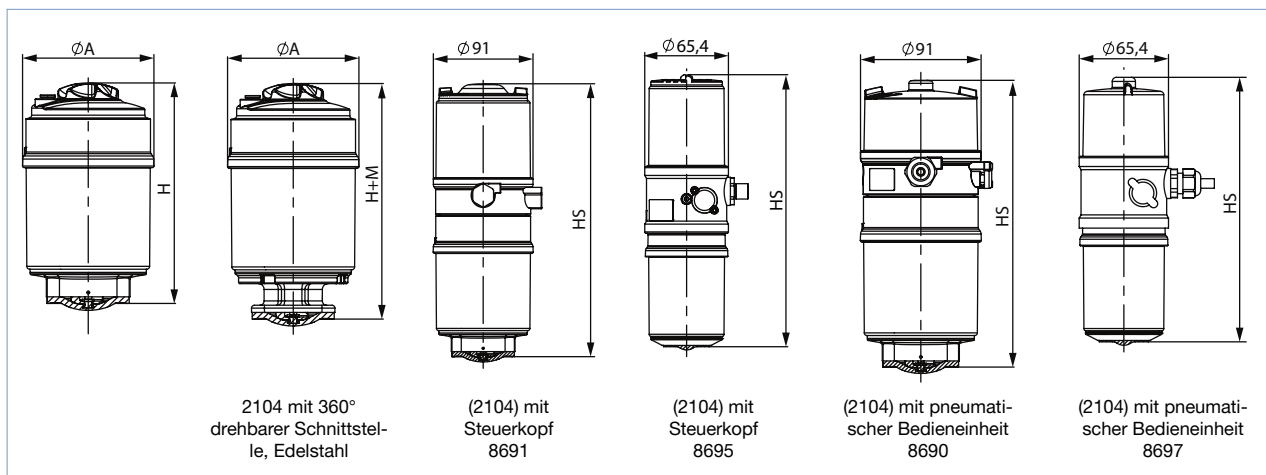

Diaphragm size	Actuator size Ø	ØA	H	HS with		H+M (MT86)
				8691/8695	8690/8697	
8	50 (D)	65	119	207	194	141
15	50 (D)	65	132	220	206	146
	70 (E)	–	–	242	209	–
20	70 (E)	92	153	248	215	165
25	70 (E)	92	154	248	215	171
	90 (N)	120	187	282	249	204
	90 (N)	120	202	297	264	215
40	90 (N)	120	206	300	268	221
	130 (P)	159	259	353	320	273
50	130 (P)	159	275	369	336	281
65	130 (P)	–	–	–	–	285

**Type 2104**  
**Pneumatically operated diaphragm**  
**valve with ELEMENT actuator**



**4.2. T-Body with welded connection**

**Note:**

Dimensions in mm, unless otherwise stated

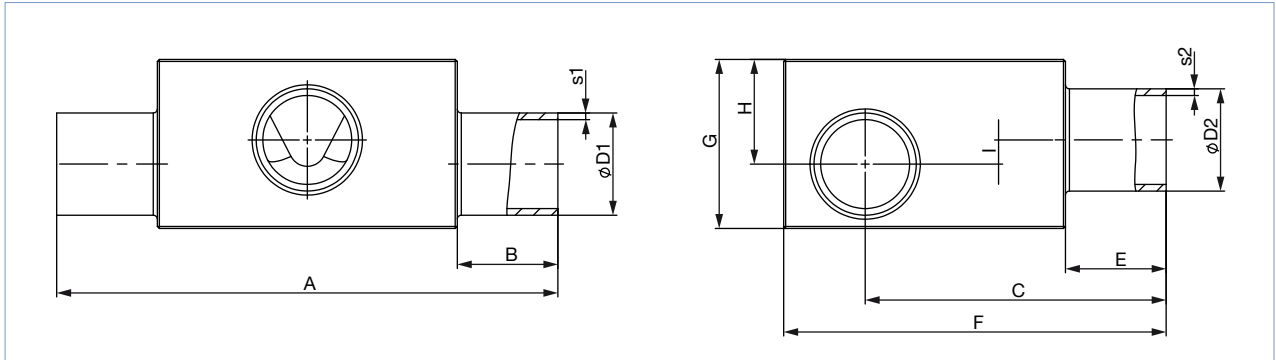

Dia- phragm size	Port 1 - Port 2 DN	ØD1	s1	ØD2	s2	A	B	C	E	F	G	H	I	Product key <sup>1,2</sup> (Port 1 - Port 2)	
<b>DIN EN ISO 1127/ISO 4200/DIN 11866 series B</b>															
8	8...8	13.5	1.6	13.5	1.6	78.0	20	47.2	20	60	24	15	5.0	SA40-SA40	
	10...8	17.2		13.5		78.0		49.00		60	29	18	8.0	SA41-SA40	
	10...10	17.2		17.2		78.0		49.00		60	29	18	8.0	SA41-SA41	
	15...8	21.3		13.5		78.0		51.1		64	34	21	11.0	SA42-SA40	
	15...10	21.3		17.2		78.0		51.1		64	34	21	11.0	SA42-SA41	
	20...8	26.9		13.5		88.0		25		53.9	70	38	23	13.0	SA43-SA40
	20...10	26.9		17.2		88.0				53.9	70	38	23	13.0	SA43-SA41
	25...8	33.7		2.0		13.5		88.0		53.9	76	45	26	16.0	SA44-SA40
	25...10	33.7				17.2		88.0		53.9	76	45	26	16.0	SA44-SA41
	32...8	42.4				13.5		88.0		60.50	84	52	29	19.0	SA45-SA40
	32...10	42.4	17.2		88.0	61.20	84	52	29	19.0	SA45-SA41				
	40...8	48.3	13.5		88.0	64.2	90	57	31	21.0	SA46-SA40				
	40...10	48.3	17.2		88.0	64.2	90	57	31	20.0	SA46-SA41				
	50...8	60.3	13.5		98.0	30	70.2	102	66	34	24.0	SA47-SA40			
	50...10	60.3	17.2		98.0		70.2	102	66	34	24.0	SA47-SA41			
	65...8	76.1	13.5		98.0		78.1	118	80	40	30.0	SA48-SA40			
	80...8	88.9	2.3		13.5		98.0	84.2	131	92	46	36.0	SA49-SA40		
	80...10	88.9		17.2	98.0	84.2	131	92	46	35.0	SA49-SA41				

DTS 1000450599 EN Version: A Status: RL (released | freigegeben | validé) printed: 10.02.2021

**Type 2104**  
**Pneumatically operated diaphragm**  
**valve with ELEMENT actuator**



Diaphragm size	Port 1 - Port 2 DN	ØD1	s1	ØD2	s2	A	B	C	E	F	G	H	I	Product key <sup>1,2)</sup> (Port 1 - Port 2)		
15	8...8	13.5	1.6	13.5	1.6	93.0	20	52.05	20	70	27	17	4.5	SA40-SA40		
	10...8	17.2		13.5		93.0		53.9		70	31	18	4.5	SA41-SA40		
	10...10	17.2		17.2		93.0		54.9		70	28	16	2.5	SA41-SA41		
	15...8	21.3		13.5		93.0		57		71	34.5	21	7.5	SA42-SA40		
	15...15	21.3		21.3		93.0		56		71	35	21	6.5	SA42-SA42		
	20...8	26.9		13.5		103.0		25		59.8	76	41	25	11.5	SA43-SA40	
	20...10	26.9		17.2		103.0				59.8	78	42	25	11.5	SA43-SA41	
	20...15	26.9		21.3		103.0				59.8	78	42	25	11.5	SA43-SA42	
	25...10	33.7		2.0		17.2				103.0	63	83	48	28	14.5	SA44-SA41
	25...15	33.7				21.3				103.0	62.8	83	47	28	14.5	SA44-SA42
	32...8	42.4				13.5				103.0	67.1	91	56	32	18.5	SA45-SA40
	32...10	42.4				17.2				103.0	67.1	91	56	32	18.5	SA45-SA41
	32...15	42.4				21.3				103.0	67.1	91	56	32	18.5	SA45-SA42
	40...8	48.3				13.5				103.0	70.1	97	63	35	21.5	SA46-SA40
	40...10	48.3	17.2		103.0	70.1	97		63	35	21.5	SA46-SA41				
	40...15	48.3	21.3		103.0	70.1	97	63	35	21.5	SA46-SA42					
	50...8	60.3	13.5		113.0	30	76.1	109	72	38	24.5	SA47-SA40				
	50...10	60.3	17.2		113.0		76.1	109	72	38	24.5	SA47-SA41				
	50...15	60.3	21.3	113.0	76.1		109	72	38	24.5	SA47-SA42					
	65...8	76.1	13.5	113.0	84		125	85	44	30.5	SA48-SA40					
	65...15	76.1	21.3	113.0	84		125	85	44	30.5	SA48-SA42					
	80...8	88.9	2.3	13.5	113.0		90.1	140	99	52	38.5	SA49-SA40				
	80...10	88.9		17.2	113.0		90.1	137	94	47	33.5	SA49-SA41				
	80...15	88.9		21.3	113.0		90.1	137	94	47	33.5	SA49-SA42				
	100...15	114.3		21.3	113.0		102.8	163	120	60	46.5	SA39-SA42				
	20	20...20		26.9	1.6		26.9	1.6	114.0	25	70.3	25	87	40	24	6.0
		25...20		33.7	2.0	26.9	114.0		73.3		94		48	28	10.0	SA44-SA43
		32...20	42.4	26.9	114.0	78.6	102		57		33		15.0	SA45-SA43		
40...20		48.3	26.9	114.0	80.6	108	63		35		17.0		SA46-SA43			
50...20		60.3	26.9	124.0	30	87	120.8		72	39	21.0		SA47-SA43			
65...20		76.1	26.9	124.0		94.5	136		86	45	27.0		SA48-SA43			
80...20		88.9	2.3	26.9		124.0	100.6		148	94	47		29.0	SA49-SA43		
100...20		114.3	26.9	124.0		113.3	173		120	60	42.0		SA39-SA43			
25	25...25	33.7	2.0	33.7	2.0	124.5	25	78.6	25	98	53	33	13.0	SA44-SA44		
	32...25	42.4		124.5		82.9		107		62	38	18.0	SA45-SA44			
	40...25	48.3		124.5		85.9		114		69	41	21.0	SA46-SA44			
	50...25	60.3		33.7		134.5	30	81.9		125	78	45	25.0	SA47-SA44		
	65...25	76.1		33.7		134.5		99.8		142	94	52	32.0	SA48-SA44		
	80...25	88.9		2.3		33.7		134.5		105.9	153	101	54	34.0	SA49-SA44	
	150...25	168.3		2.6		33.7		134.5		145.3	232	174	87	67.0	SA69-SA44	
40	32...32	42.4	2.0	42.4	2.0	152.0	25	98.00	25	122	62	38	9.4	SA45-SA45		
	40...32	48.3		152.0		100		128		68	41	12.4	SA46-SA45			
	40...40	48.3		152.0		100		128		68	41	12.4	SA46-SA46			
	50...32	60.3		42.4		162.0	30	106		140	82	48	19.4	SA47-SA45		
	50...40	60.3		48.3		162.0		106		140	82	48	19.4	SA47-SA46		
	65...40	76.1		48.3		162.0		113.9		155	97	55	26.4	SA48-SA46		
	80...32	88.9		2.3		42.4		162.0		120	168	108	60	31.4	SA49-SA45	
	80...40	88.9				48.3	162.0	120		168	108	60	31.4	SA49-SA46		
	100...32	114.3				42.4	162.0	132.7		193	129	68	39.4	SA39-SA45		
	100...40	114.3				48.3	162.0	132.7		193	129	68	39.4	SA39-SA46		
	50	50...50				60.3	2.0	60.3		2.0	188.0	30	120.2	30	154	82
65...50		76.1	60.3	188.0	128.1	170		100	56		20.5		SA48-SA47			
80...50		88.9	2.3	60.3	188.0	134.2		183	110		61		25.5		SA49-SA47	
100...50		114.3	60.3	188.0	146.9	208		131	70		34.5	SA39-SA47				
150...50		168.3	2.6	60.3	188.0	173.6		261	176		88	52.5	SA69-SA47			

DTS 1000450599 EN Version: A Status: RL (released | freigegeben | valide) printed: 10.02.2021



**Type 2104**  
**Pneumatically operated diaphragm**  
**valve with ELEMENT actuator**



Diaphragm size	Port 1 - Port 2 DN	ØD1	s1	ØD2	s2	A	B	C	E	F	G	H	I	Product key <sup>1,2)</sup> (Port 1 - Port 2)
<b>DIN 11850 series 2/DIN 11866 series A/DIN EN 10357 series A</b>														
8	10...10	13.0	1.5	13.0	1.5	78.0	20	47.0	20	60	24	15	5.0	SD40-SD40
	20...10	23.0		13.0		88.0	25	52.0		66	36	22	12.0	SD43-SD40
15	15...15	19.0	1.5	19.0	1.5	93.0	20	55.9	20	70	33	20	6.5	SD42-SD42
	20...15	23.0		19.0		103.0		57.9		72	37	22.5	9	SD43-SD42
	25...15	29.0		19.0		103.0	25	60.9		78	43	26	12.5	SD44-SD42
	32...15	35.0		19.0		103.0		63.9		84	49	29	15.5	SD45-SD42
	40...15	41.0		19.0		103.0		66.9		91	56	31	17.5	SD46-SD42
	50...15	53.0		19.0		113.0	30	72.9		102	65	36	22.5	SD47-SD42
20	20...20	23.0	1.5	23.0	1.5	114.0	25	68.7	25	85	36	21	-	SD43-SD43
	32...20	35.0		23.0		114.0		74.4		95	50	29	11.0	SD45-SD43
	40...20	41.0		23.0		114.0		77.4		101	56	32	14.0	SD46-SD43
25	25...25	29.0	1.5	29.0	1.5	124.5	25	76.7	25	98	48	30	10.0	SD44-SD44
	40...25	41.0		29.0		124.5		82.7		106	61	38	18.0	SD46-SD44
	50...25	53.0		29.0		134.5	30	88.7		120	73	44	24.0	SD47-SD44
40	32...32	35.0	1.5	35.0	1.5	152.0	25	95	25	119	52	32	9	SD45-SD45
	40...40	41.0		41.0		152.0		97.3		121	62	37	8.4	SD46-SD46
	50...40	53.0		41.0		162.0	30	102.8		133	75	45	16.4	SD47-SD46
50	50...50	53.0	1.5	53.0	1.5	188.0	30	117.0	30	147	74	44	8.5	SD47-SD47
<b>ASME BPE/DIN 11866 series C</b>														
8	20...8	19.05	1.65	6.35	0.89	88.0	25	49.90	20	61	32	20	10.0	SA93-SA90
	25...10	25.40		9.53		78.0	20	53.00		68	38	23	13.0	SODF-SA91
	40...8	38.10		6.35		88.0	25	59.40		80	49	28	18.0	SODH-SA90
	50...8	50.80		6.35		98.0	30	65.80		93	59	32	22.0	SODI-SA90
	65...8	63.50		6.35		98.0		72.10		106	70	36	26.0	SODJ-SA90
15	15...15	12.70	1.65	12.70	1.65	93.0	20	53.20	20	70	27	13.5	-	SA92-SA92
	20...15	19.05		12.70		103.0		55.80		70	31	18.5	5.0	SA93-SA92
	25...15	25.40		12.70		103.0		59.00		75	40	24	10.5	SODF-SA92
	40...15	38.10		12.70		103.0	25	65.30		88	54	31	17.5	SODH-SA92
	50...15	50.80		12.70		113.0	30	71.70		100	64	35	21.5	SODI-SA92
	65...15	63.50		12.70		113.0		78.00		113	73	38	24.5	SODJ-SA92
	80...15	76.20		12.70		113.0		84.40		125	84	43	29.5	SODK-SA92
20	20...20	19.05	1.65	19.05	1.65	114	25	66.30	25	85	36	18	-	SA93-SA93
	25...20	25.40		19.05		114		69.20		88	40	24	6.0	SODF-SA93
	40...20	38.10		19.05		114		75.80		98	53	31	13.0	SODH-SA93
	50...20	50.80		19.05		124	30	82.20		111	66	37	19.0	SODI-SA93
	65...20	63.50		19.05		124		88.50		123	75	40	22.0	SODJ-SA93
	80...20	76.20		19.05		124		94.90		136	85	44	26.0	SODK-SA93
	100...20	101.60	2.11	19.05		124		107.10		161	108	54	36.0	SODL-SA93
25	25...25	25.40	1.65	25.40	1.65	124.5	25	74.8	25	95	42	26	6.0	SODF-SODF
	40...25	38.10		25.40		124.5		81.1		103	58	36	16.0	SODH-SODF
	50...25	50.80		25.40		134.5	30	87.5		120	75	44	24.0	SODI-SODF
	65...25	63.50		25.40		134.5		93.8		129	82	47	27.0	SODJ-SODF
	80...25	76.20		25.40		134.5		100.15		142	94	52	32.0	SODK-SODF
40	40...40	38.10	1.65	38.10	1.65	152.0	25	99.60	25	121	58	35	6.4	SODH-SODH
	50...40	50.80		38.10		162.0	30	101.6		131	72	43	14.4	SODI-SODH
	65...40	63.50		38.10		162.0		107.90		143	85	50	21.4	SODJ-SODH
	80...40	76.20		38.10		162.0		114.3		156	98	56	27.4	SODK-SODH
50	50...50	50.80	1.65	50.80	1.65	188.0	30	115.8	30	145	71	42	6.5	SODI-SODI
	65...50	63.50		50.80		188.0		122.10		157	85	50	14.5	SODJ-SODI
	65...65	63.50		63.50		188.0		122.10		158	86	50	14.5	SODJ-SODJ
	80...50	76.20		50.80		188.0		128.5		169	98	56	20.5	SODK-SODI
	100...65	101.60	2.11	63.50		188.0		140.7		195	120	66	30.5	SODL-SODJ

DTS 1000450599 EN Version: A Status: RL (released | freigegeben | valide) printed: 10.02.2021

**Type 2104**  
**Pneumatically operated diaphragm**  
**valve with ELEMENT actuator**



Dia- phragm size	Port 1 - Port 2 DN	ØD1	s1	ØD2	s2	A	B	C	E	F	G	H	I	Product key <sup>1.)</sup> (Port 1 - Port 2)			
<b>SMS 3008</b>																	
25	25...25	25.0	1.2	25.0	1.2	124.5	25	75.0	25	95	43	27	7.0	SA60-SA60			
	40...25	38.0		25.0		124.5		81.5		103				58	36	16.0	SA62-SA60
	50...25	51.0	25.0	134.5	30	88.0	118	72	42	22.0	SA63-SA60						
40	40...40	38.0	1.2	38.0	1.2	152.0	25	95.6	25	121	58	35	6.4	SA62-SA62			
	50...40	51.0		38.0		162.0		30		102.1				131	73	44	15.4
50	50...50	51.0	1.2	51.0	1.2	188.0	30	120.2	30	154	82	48	2.5	SA63-SA63			
<b>DIN 11850 series 0</b>																	
8	04...04	6.0	1.0	6.0	1.0	78.0	20	44.0	20	60	15	6.5	0.0	SC40-SC40			
	06...06	8.0		8.0		75.0		17.5		46.5				60	13	7	0.0
	40...04	40.0	1.5	6.0	1.5	88.0	25	60.5	25	83	51	29	19.0	SC47-SC40			
	40...8	40.0		10.0		88.0		60.5		83				51	29	19.0	SC47-SC42
	50...04	52.0		6.0		98.0		30		66.5				95	60	32	22.0
15	50...15	52.0	1.5	18.0	1.5	113.0	30	72.4	20	101	65	36	22.5	SC48-SC43			
25	25...25	28.0	1.5	28.0	1.5	124.5	25	76.2	25	95	46	29	9.0	SC45-SC45			
	50...25	52.0		28.0		134.5		30		91.2				120	71	42	22.0
40	25...32	28.0	1.5	34.0	1.5	152.0	25	90.3	25	122	58	32	3.4	SC45-SC46			
	50...32	52.0		34.0		162.0		30		102.3				132	75	45	16.4
50	50...50	52.0	1.5	52.0	1.5	188.0	30	116.5	30	147	73	43	7.5	SC48-SC48			

1.) This information is part of the product key (see product enquiry form at the end of this data sheet)

**4.3. T-Body with Clamp-connection**

**Note:**

- Dimensions in mm, unless otherwise stated
- Clamp dimensions must be added to the welded connection dimensions.

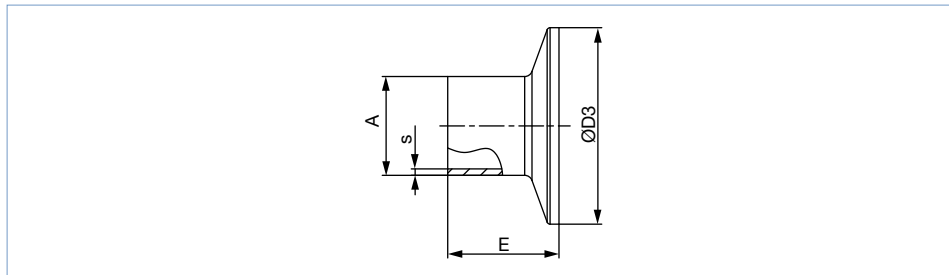

Port connection		A	s	D3	E	Product key <sup>1.)</sup>
[mm]	[inch]					
<b>DIN 32676 series A (DIN pipe)</b>						
10	-	13	1.5	34.0	18	TD41
15	-	19	1.5	34.0	18	TD42
20	-	23	1.5	34.0	18	TD43
25	-	29	1.5	50.5	21.5	TD44
32	-	35	1.5	50.5	21.5	TD45
40	-	41	1.5	50.5	21.5	TD46
50	-	53	1.5	64.0	21.5	TD47
<b>DIN 32676 series B (ISO pipe)</b>						
8	-	13.5	1.6	25.0	28.6	TC40
8	-	13.5	1.6	34.0 <sup>2.)</sup>	28.6	TC51 <sup>2.)</sup>
10	-	17.2	1.6	34.0 <sup>2.)</sup>	28.6	TC41 <sup>2.)</sup>
15	-	21.3	1.6	34.0 <sup>2.)</sup>	28.6	TC42 <sup>2.)</sup>
15	-	21.3	1.6	50.5	28.6	TC52
20	-	26.9	1.6	50.5	28.6	TC43
25	-	33.7	2	50.5	28.6	TC44
32	-	42.4	2	50.5 <sup>2.)</sup>	28.6	TC45 <sup>2.)</sup>
40	-	48.3	2	64.0	28.6	TC46
50	-	60.3	2	77.5	28.6	TC47
<b>ASME BPE</b>						
8	1/4"	6.35	0.89	25.0	28.6	TG50
10	3/8"	9.53	0.89	25.0	28.6	TG01
15	1/2"	12.7	1.65	25.0	28.6	TG02
20	3/4"	19.05	1.65	25.0	28.6	TG03
25	1"	25.4	1.65	50.5	28.6	TG04
40	1 1/2"	38.1	1.65	50.5	28.6	TG05
50	2"	50.8	1.65	64.0	28.6	TG06

1.) This information is part of the product key (see product enquiry form at the end of this data sheet)

2.) Deviating from the standard, because of different clamp outer diameter.

## 5. Performance specifications

### 5.1. Medium pressure

#### Information for control function A

**Note:**

- For low operating pressures, optional versions with reduced spring force (**EC04**) are recommended.
- Pressure data [bar]: Overpressure to atmospheric pressure. Valve closes dynamically against max. operating pressure.
- Information for control function B and I on request.

Diaphragm size	Actuator size Ø	Pilot pressure	Max. operating pressure for seal material	
			EPDM, FKM	PTFE/EPDM, advanced PTFE/EPDM, GYLON®/EPDM laminated
DN	[mm]	[bar]	[bar]	[bar]
8	50 (D)	5.0...10	10	10
15	50 (D)	5.0...10	7.5	–
	70 (M)		10	10
20	70 (M)	5.0...10	10	10
25	70 (M)	5.0...10	6.5	4.5
	90 (N)		10	8
40	90 (N) <sup>1.)</sup>	5.5...10	5.5	5
	130 (P)		10	10
50	130 (P)	5.0...7	8	7
65	130 (P)	5.0...7	5.5	3.5

1.) Gylon version is not available

## 6. Product accessories

Process controller TopControl	
Type 8693 ▶ Actuator size Ø 70/90/130 mm	Description
	<p>The intelligent process controller Type 8693 is designed for integrated mounting on pneumatic actuators from the process control valve series Type 23xx/2103 and especially for the requirements of hygienic process conditions. Using the TUNE-Functions, the process controller and positioner can be initialized automatically. Easy operation and selection of additional software functions as well as parameterization are carried out via the large graphic display and the keypad. Device configuration and parameterization can also be conveniently carried out by the Bürkert Communicator software tool via a PC interface.</p> <p><b>Features</b></p> <ul style="list-style-type: none"> <li>• Contact-free position sensor</li> <li>• Universal positioning system for single and double-acting actuators</li> <li>• Ultra dynamic positioning system without air consumption in steady state</li> <li>• Integrated diagnostic functions for valve monitoring</li> <li>• Automatic initialization of the positioner and process controller using the TUNE-Function</li> <li>• Defined safe position in case of electrical or pneumatic auxiliary power failure</li> <li>• PROFIBUS DP-V1, DeviceNet, EtherNet/IP, PROFINET, Modbus TCP, Bürkert system bus (büS)</li> <li>• Compact and robust hygienic stainless steel design</li> </ul> <p><b>Customer benefits</b></p> <ul style="list-style-type: none"> <li>• Quick and easy commissioning</li> <li>• Intuitive and simple operation via graphic display with backlight and keypad</li> <li>• High degree of system availability due to increased actuator service life by means of spring chamber ventilation</li> <li>• Guaranteed reliability and predictable maintenance through valve monitoring and diagnostics</li> <li>• Easy maintenance and process monitoring</li> </ul>

Positioner TopControl	
<b>Type 8692 ▶</b> <b>Actuator size Ø 70/90/130 mm</b>	<b>Description</b> <p>The intelligent electropneumatic positioner Type 8692 is designed for integrated attachment to pneumatic actuators of the process control valve series Type 23xx/2103 and especially for the requirements of hygienic process conditions. The positioner can be initialized automatically using the TUNE-Function. Easy operation and the selection of the extensive additional software functions as well as parameterization are carried out via the large graphic display and keypad. The device configuration and parameterization can also be conveniently carried out using the Bürkert Communicator software tool via a PC interface.</p> <p><b>Features</b></p> <ul style="list-style-type: none"> <li>• Contact-free position sensor</li> <li>• Universal positioning system for single and double-acting actuators</li> <li>• Ultra dynamic positioning system without air consumption in steady state</li> <li>• Integrated diagnostic functions for valve monitoring</li> <li>• Automatic initialization of the positioner by means of the TUNE-Function</li> <li>• Defined safe position in case of electrical or pneumatic auxiliary power failure</li> <li>• PROFIBUS DP-V1, DeviceNet, EtherNet/IP, PROFINET, Modbus TCP, Bürkert system bus (büS)</li> <li>• Compact and robust hygienic stainless steel design</li> </ul> <p><b>Customer benefits</b></p> <ul style="list-style-type: none"> <li>• Quick and easy commissioning</li> <li>• Intuitive and simple operation via graphic display with backlight and touch keypad</li> <li>• High degree of system availability due to increased actuator service life by means of spring chamber ventilation</li> <li>• Guaranteed reliability and predictable maintenance through valve monitoring and diagnostics</li> </ul>
	
Positioner TopControl BASIC	
<b>Type 8694 ▶</b> <b>Actuator size Ø 70/90/130 mm</b>	<b>Description</b> <p>The compact positioner Type 8694/8696 is designed for integrated attachment to pneumatic actuators of the Type 23xx/2103 process control valve series and especially for the requirements of hygienic process conditions. Operation and parameterization are performed via push buttons and DIP switches. The device configuration and parameterization can also be conveniently carried out using the Bürkert Communicator software tool via a PC interface.</p> <p><b>Features</b></p> <ul style="list-style-type: none"> <li>• Contact-free position sensor</li> <li>• Universal positioning system for single and double-acting actuators</li> <li>• Ultra dynamic positioning system without internal control air consumption</li> <li>• AS-Interface, IO-Link, Bürkert system bus (büS) (only 8694)</li> <li>• Compact and robust hygienic stainless steel design</li> </ul> <p><b>Customer benefits</b></p> <ul style="list-style-type: none"> <li>• Simple and safe commissioning through Teach-In function</li> <li>• Minimum space requirement in the plant pipework for more flexibility in plant design</li> <li>• High degree of system availability due to increased actuator service life by means of spring chamber ventilation</li> </ul>
	
<b>Type 8696 ▶</b> <b>Actuator size Ø 50 mm</b>	
	

DTS 1000450599 EN Version: A Status: RL (released | freigegeben | valide) printed: 10.02.2021

Process controller SideControl Remote	
Type 8793 ▶ with Remote Sensor 8798 ▶ Actuator size Ø 70/90/130 mm	Description
	<p>The intelligent digital positioner/process controller Type 8793 is designed for mounting on lift or swivel drives with standardization in accordance with IEC 534 - 6 or VDI/VDE 3845 and is designed for demanding control tasks. The version with remote position sensor Type 8798 is used to control Bürkert process control valves. It is operated via a backlit graphic display. The initialization of process and positioner can be done automatically by means of TUNE-Function. Here the type of controlled system is automatically recognized and the appropriate controller structure with the corresponding optimum parameter set is determined.</p> <p><b>Features</b></p> <ul style="list-style-type: none"> <li>• Universal control system for single and double-acting actuators</li> <li>• Integrated diagnostic functions for valve monitoring</li> <li>• Automatic initialization of the position and process controller by means of TUNE-Function</li> <li>• Ultra dynamic actuating system without internal control air consumption.</li> <li>• Illuminated graphic display with keypad</li> <li>• PROFIBUS DP-V1, DeviceNet, EtherNet/IP, PROFINET, Modbus TCP, Bürkert system bus (büs)</li> <li>• Compact and robust design</li> <li>• Adaptation acc. to IEC 534 - 6 or VDI/VDE 3845 for lift and swivel drives or as remote version on Bürkert process valves</li> </ul> <p><b>Customer benefits</b></p> <ul style="list-style-type: none"> <li>• Quick and easy commissioning</li> <li>• Intuitive and simple operation via graphic display with backlight and keypad.</li> <li>• Guaranteed reliability and scheduled maintenance thanks to valve monitoring and diagnostics.</li> <li>• Easy maintenance and process monitoring</li> <li>• Long service life</li> </ul>

Positioner SideControl Remote	
<b>Positioner Type 8792 ▶ with Remote Sensor Type 8798 ▶ Actuator size Ø 70/90/130 mm</b>	<b>Description</b> <p>The intelligent digital position/process controller Type 8792 is designed for attachment to lift and swivel drives with standardization according to IEC 534 - 6 or VDI/VDE 3845 for demanding control tasks. The Type 8798 version with remote position sensor is used to control Bürkert process control valves. It is operated via a backlit graphic display. The initialization of process and positioner can be done automatically by means of TUNE-Function.</p> <p><b>Features</b></p> <ul style="list-style-type: none"> <li>• Illuminated graphic display with touch screen</li> <li>• Universal control system for single and double-acting actuators</li> <li>• Ultra dynamic actuating system without internal control air consumption.</li> <li>• Integrated diagnostic functions for valve monitoring</li> <li>• PROFIBUS DP-V1, DeviceNet, EtherNet/IP, PROFINET, Modbus TCP, Bürkert system bus (büS)</li> <li>• Compact and robust design</li> <li>• Adaptation acc. to IEC 534 - 6 or VDI/VDE 3845 for lift and swivel drives or as remote version on Bürkert process valves</li> </ul> <p><b>Customer benefits</b></p> <ul style="list-style-type: none"> <li>• Quick and easy commissioning</li> <li>• Intuitive and simple operation via backlit graphic display and keypad.</li> <li>• Guaranteed reliability and scheduled maintenance thanks to valve monitoring and diagnostics.</li> <li>• Long service life</li> </ul>
	
Positioner SideControl BASIC Remote	
<b>Positioner Type 8791 ▶ with Remote Sensor Type 8798 ▶ Actuator size Ø 70/90/130 mm</b>	<b>Description</b> <p>The positioner Type 8791 is designed for mounting on lift or swivel drives with standardization in accordance with IEC 534 - 6 or VDI/VDE 3845 designed for simple control tasks. The variant with the remote sensor Type 8798 is used to control Bürkert process control valves. All operating elements are located inside the housing.</p> <p><b>Features</b></p> <ul style="list-style-type: none"> <li>• Simple design</li> <li>• Universal control system for single and double-acting actuators</li> <li>• Ultra dynamic positioning system without air consumption in steady state</li> <li>• Adaptation according to IEC 534 - 6 or VDI/VDE 3845 for lift and swivel drives or as remote version on Bürkert process valves</li> <li>• AS-Interface, IO-Link, Bürkert system bus (büS) (only for Positioner Type 8791 BASIC Remote)</li> </ul> <p><b>Customer benefits</b></p> <ul style="list-style-type: none"> <li>• Quick and easy commissioning</li> <li>• Simple device for simple control tasks</li> <li>• Low energy consumption</li> </ul>
	
<b>Positioner IP20 Type 8791 ▶ with Remote Sensor Type 8798 ▶ Actuator size Ø 70/90/130 mm</b>	
	

DTS 1000450599 EN Version: A Status: RL (released | freigegeben | validé) printed: 10.02.2021



**Type 2104**  
**Pneumatically operated diaphragm**  
**valve with ELEMENT actuator**

Control head	
<b>Type 8691 ▶</b> <b>Actuator size Ø 70/90/130 mm</b>	<b>Description</b>  The control heads, Type 8691 and 8695, are optimized for integrated mounting on process valves of the 21XX series. The valve position is detected without contact via an analogue sensor element, which automatically detects and stores the valve end positions during commissioning using the Teach-In function. The integrated pilot valve controls single or double-acting actuators. The switching status of the valve is indicated by coloured high-performance LEDs.
	<b>Features</b> <ul style="list-style-type: none"> <li>• Status indication via coloured high-power LEDs</li> <li>• Non-wearing inductive position sensor</li> <li>• Pilot valve with manual override</li> </ul>
<b>Type 8695 ▶</b> <b>Actuator size Ø 50 mm</b>	<b>Description</b>  The control heads, Type 8691 and 8695, are optimized for integrated mounting on process valves of the 21XX series. The valve position is detected without contact via an analogue sensor element, which automatically detects and stores the valve end positions during commissioning using the Teach-In function. The integrated pilot valve controls single or double-acting actuators. The switching status of the valve is indicated by coloured high-performance LEDs.
	<b>Features</b> <ul style="list-style-type: none"> <li>• Teach-In function for automatic recognition of the valve end positions</li> <li>• Hygienic stainless steel design</li> <li>• Easy to clean chemical resistant housing according to IP65/67, 4X rating</li> <li>• AS-Interface, DeviceNet, IO-Link, Bürkert system bus (büS)</li> </ul> <b>Customer benefits</b> <ul style="list-style-type: none"> <li>• Simple and safe commissioning by means of Teach-In function</li> <li>• Easy process monitoring and fault detection through visible coloured high-power LEDs</li> <li>• High degree of system availability due to increased actuator service life by means of spring chamber ventilation</li> <li>• Minimal space requirement in the plant piping for more flexibility in plant design</li> </ul>
Pneumatic control unit/Position feedback	
<b>Type 8690 ▶</b> <b>Actuator size Ø 70/90/130 mm</b>	<b>Description</b>  The pneumatic control units, Type 8690 and 8697, are optimized for integrated mounting on process valves of the 21XX series. Mechanical or inductive limit switches detect the valve position. The integrated pilot valve controls single or double-acting (Type 8690) actuators.
	<b>Features</b> <ul style="list-style-type: none"> <li>• Optical position indicator</li> </ul>
<b>Type 8697 ▶</b> <b>Actuator size Ø 50 mm</b>	<b>Description</b>  The pneumatic control units, Type 8690 and 8697, are optimized for integrated mounting on process valves of the 21XX series. Mechanical or inductive limit switches detect the valve position. The integrated pilot valve controls single or double-acting (Type 8690) actuators.
	<b>Features</b> <ul style="list-style-type: none"> <li>• Mechanical or inductive proximity switches for end position detection</li> <li>• Pilot valve with manual override</li> <li>• Compact design</li> <li>• Easy to clean, chemical resistant housing according to IP65/67, 4X rating</li> <li>• Optional intrinsically safe design according to ATEX/IECEX</li> </ul> <b>Customer benefits</b> <ul style="list-style-type: none"> <li>• Simple and safe commissioning using the Teach-In function (Type 8697)</li> <li>• Signal reliability due to the automatic adjustment of the limit position switches</li> <li>• Minimal space requirement in the plant piping for more flexibility in plant design</li> </ul>

DTS 1000450599 EN Version: A Status: RL (released | freigegeben | validé) printed: 10.02.2021

## 7. Networking and combination with other Bürkert products

### 7.1. Possible combinations for ELEMENT control valve system Type 8802-TB with TopControl

The continuous ELEMENT valve system, Type 8802-TB, consists of a diaphragm valve, Type 2104, and a digital electropneumatic positioner, Type 8692 (for valve actuator size Ø 70/90/130 mm), a digital electropneumatic process controller, Type 8693 (for valve actuator size Ø 70/90/130 mm), a basic digital electropneumatic positioner, Type 8694 (for valve actuator size Ø 70/90/130 mm) or a digital electropneumatic positioner, Type 8696 (for valve actuator size Ø 50 mm).

**Note:**

You order two components and receive a completely assembled and tested valve.

**Example:**

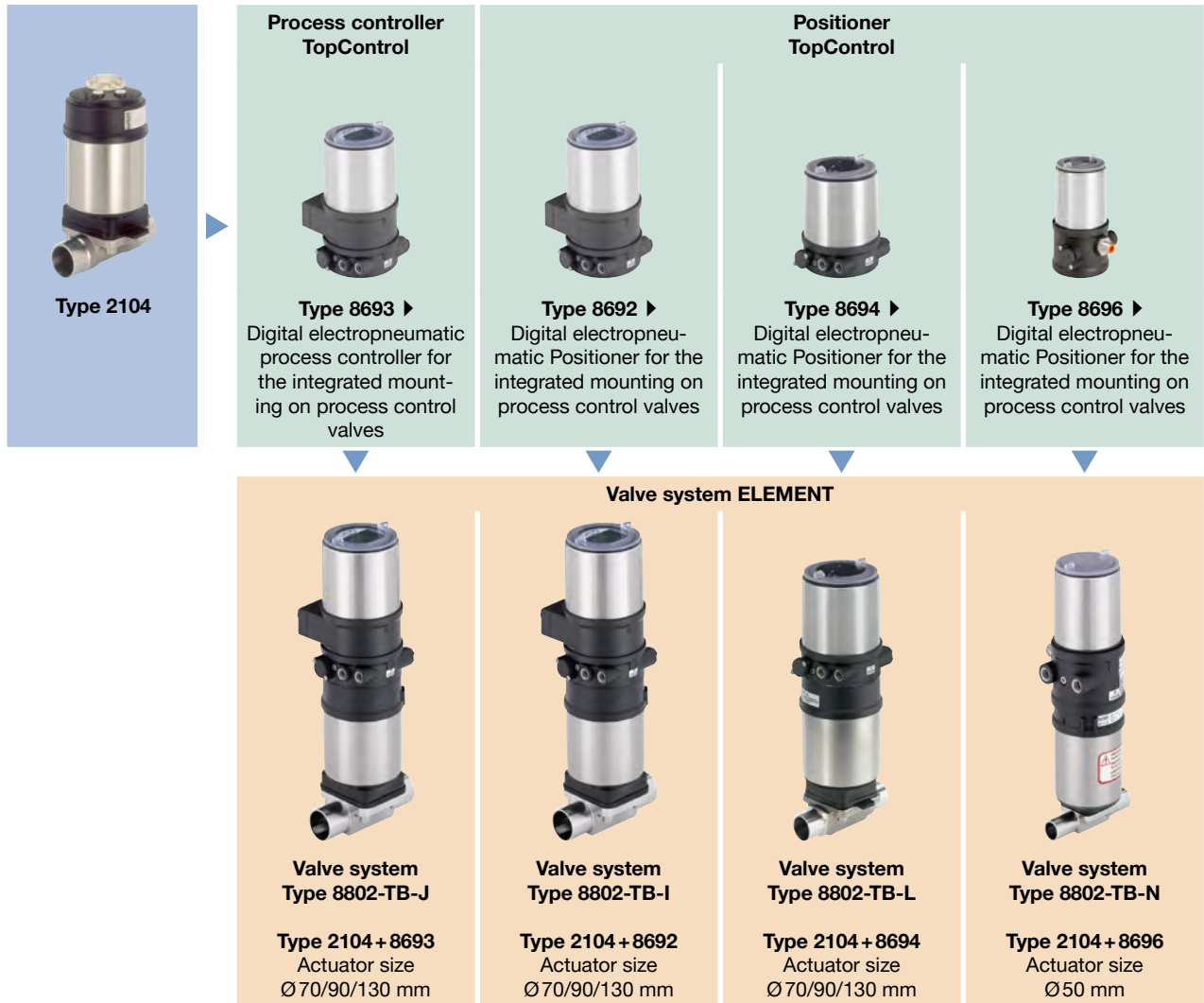

**Type 2104**  
**Pneumatically operated diaphragm**  
**valve with ELEMENT actuator**

**7.2. Possible combinations for control valve system ELEMENT Type 8802-TB with SideControl Remote**

The continuous ELEMENT valve system, Type 8802-TB with SideControl, consists of a diaphragm valve, Type 2104 and a digital electropneumatic SideControl process controller Type 8793 (for valve actuator size Ø 70/90/130 mm) or a digital electropneumatic SideControl positioner Type 8792/8791 (for valve actuator size Ø 70/90/130 mm). The SideControls can only be used in combination with the position measuring system Type 8798.

**Note:**

You order two components and receive a completely assembled and tested valve.

**Example:**

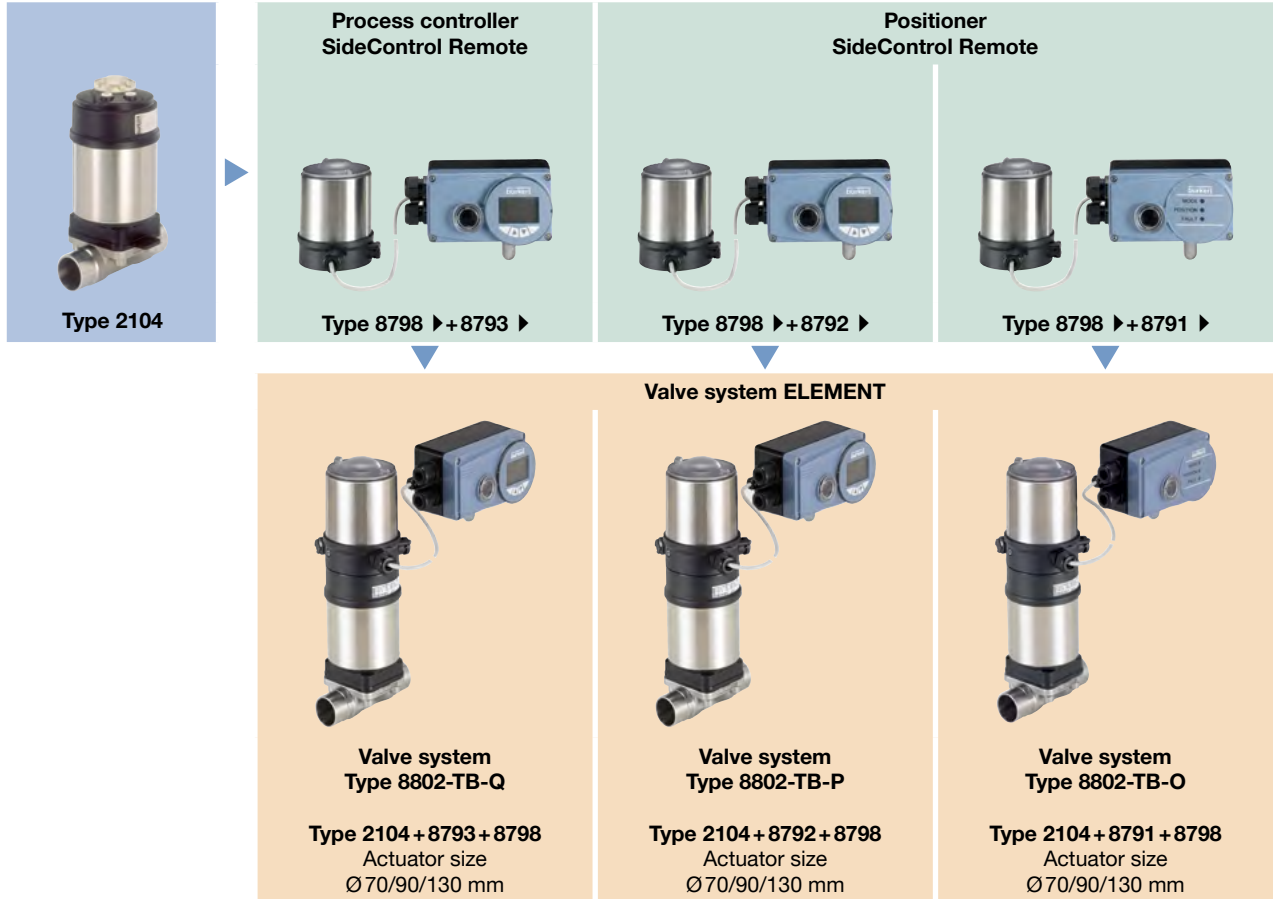

**Type 2104**  
**Pneumatically operated diaphragm**  
**valve with ELEMENT actuator**

**7.3. Possible combinations for ELEMENT control valve system Type 8801-TB with control head or pneumatic control unit/position feedback**

A decentralized automated **valve system On/Off ELEMENT, Type 8801-TB**, consists of a **diaphragm valve, Type 2104**, and a **valve control head Type 8691/8695** or a **pneumatic control unit Type 8690/8697**.

**Note:**

You order two components and receive a completely assembled and tested valve.

**Example:**

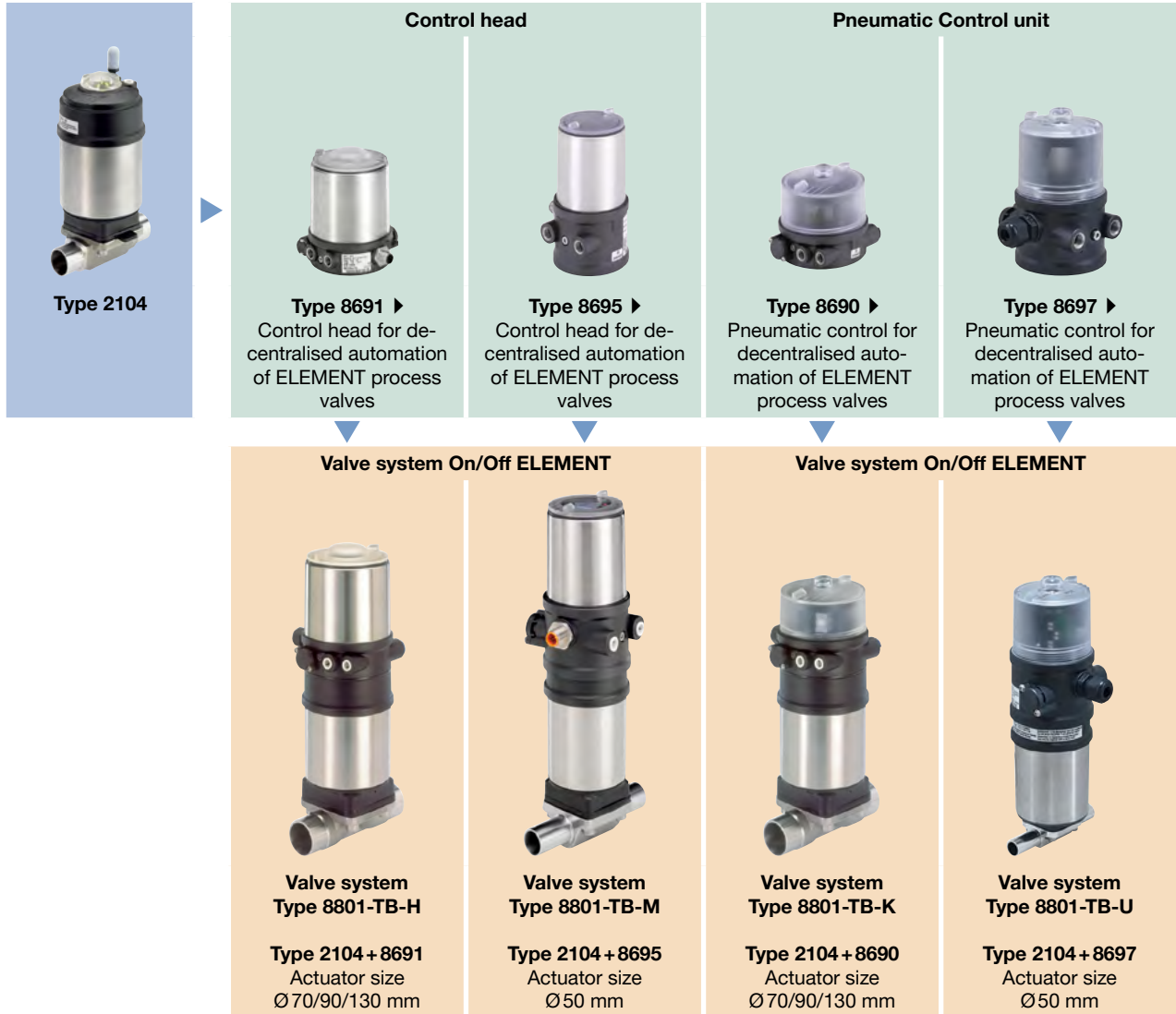

## 8. Ordering information

### 8.1. Bürkert eShop – Easy ordering and quick delivery



#### Bürkert eShop – Easy ordering and fast delivery

You want to find your desired Bürkert product or spare part quickly and order directly? Our online shop is available for you 24/7. Sign up and enjoy all the benefits.

[Order online now](#)

### 8.2. Bürkert product filter



#### Bürkert product filter – Get quickly to the right product

You want to select products comfortably based on your technical requirements? Use the Bürkert product filter and find suitable articles for your application quickly and easily.

[Try out our product filter](#)

### 8.3. Bürkert product enquiry form

**Bürkert product enquiry form:** Would you like to make a specific product enquiry based on your technical requirements? Please use our product enquiry form **at the end of this data sheet**. There you will find all the information relevant to your Bürkert contact person that will help us to process your enquiry in the best possible way.

**Bürkert specification key:** In our product enquiry form you will find a complete explanation of the composition of our specification key. You will find our product enquiry form **at the end of this data sheet**.

# Bürkert – Close to You

For up-to-date addresses  
please visit us at  
[www.burkert.com](http://www.burkert.com)

DTS 1000450599 EN Version: A Status: RL (released | freigegeben | validé) printed: 10.02.2021



**Product Enquiry Form**  
**Diaphragm valve with straight**  
**way valve, T-valve or tank bottom**  
**valve**



**Product Enquiry Form - Diaphragm valve with globe valve, T-valve or**  
**tank bottom valve**

Thank you for your interest in our products! In order to provide you with optimum advice, please fill out the following form and send it to your **Bürkert representative** or e-mail address: [info@burkert.com](mailto:info@burkert.com). All information submitted will of course be kept strictly confidential.

Please fill in the **required fields!**  \*

\***Note:** The interactive functions of this PDF may be restricted depending on the PDF reader used.

Personal Information			
<b>Company</b>		<b>Contact person</b>	
<b>Customer no.</b>		<b>Department</b>	
<b>Street</b>		<b>Postcode / Town</b>	
<b>Telephone no.</b>		<b>Email</b>	

Delivery
Required delivery date

Operating data					
<b>Process medium</b>					
<b>Medium</b>	Liquid	Steam	Gas	CIP	SIP
<b>Medium temperature</b>	T <sub>med</sub>				
<b>Medium pressure</b>	P <sub>med</sub>				

Valve data				
<b>Surface quality (valid for stainless steel)</b>	Standard:	Ra 0.5 internal	Ra 0.38 e-pol internal	Plastic
	Non standard:	internal	external	
<b>Body material</b>				
<b>Body design</b>	2 way valve	T-valve	Tank bottom valve	
<b>Seal material</b>	EPDM	PTFE	GYLON®	others
<b>Nominal diameter</b>	DN			
<b>Pilot pressure</b>	min.		max.	
<b>Connection</b>	<b>Weld end</b>	EN ISO 1127 / ISO 4200 DIN 11866 R. B	DIN 11850 DIN 11866 R. A	ASME BPE DIN 11866 R. C
	<b>Clamp connection</b>	DIN 32676 R. B (ISO tube (ISO4200))	DIN 32676 R. A (DIN tube (DIN11850))	ASME BPE
	<b>Plastic</b>	Flange	Threated	Spigot
	<b>Others</b>			

Article no. (if known)
Are you interested in ordering a complete Valve System Open/Close or Continuous? For more information on Valve Systems Open/Close or Continuous, please visit our <a href="#">Website</a> ►.

Additional Requirements / Comment

DTS 1000450599 EN Version: A Status: RL (released | freigegeben | valide) printed: 10.02.2021

## Specification key

**Note:**

- Please fill out this Product Inquiry Form as completely as possible!
- For more information on Valve Systems Open/Close or Continuous, please visit our **Website** ►.
- See **Specification key - Examples** how to fill in the specification key.





Key Feature	Quantity	Type	Control function	Nominal diameter diaphragm	Diaphragm material	Body material	Port connection	Port connection	Actuator version	Actuator size	Pilot air port	Actuator	Variable	Variable	Variable	
		TYP	SF	DN	DWST	WKST	LTA1	LTA2	ANTA	ANTG	STLA	ANTR	* VAR1	VAR2	VAR3	
Key No. →		1	2	3	4	5	6	6	7	8	9	10	V1	V2	V3	
1 Selection →													*			
	Comments															
2 Selection →													*			
	Comments															
3 Selection →													*			
	Comments															
4 Selection →													*			
	Comments															
5 Selection →													*			
	Comments															
6 Selection →													*			
	Comments															





DTS 1000450599 EN Version: A Status: RL (released | freigegeben | valide) printed: 10.02.2021



## Specification key - Examples

2 way diaphragm valve					
<b>Type 2030 ▶</b> CLASSIC with plastic body 	<b>Type 2031 ▶</b> CLASSIC with stainless steel body 	<b>Type 2063 ▶</b> INOX with stainless steel body 	<b>Type 2103 ▶</b> ELEMENT with stainless steel or plastic body 	<b>Type 3232 ▶</b> Manually operated with plastic body 	<b>Type 3233 ▶</b> Manually operated with stainless steel body 

T-diaphragm valve			
<b>Type 2032 ▶</b> CLASSIC T-valve 	<b>Type 2064 ▶</b> INOX T-valve 	<b>Type 2104 ▶</b> ELEMENT T-valve 	<b>Type 3234 ▶</b> Manually operated T-valve 

Tank bottom diaphragm valve			
<b>Type 2033 ▶</b> CLASSIC Tank bottom valve 	<b>Type 2065 ▶</b> INOX Tank bottom valve 	<b>Type 2105 ▶</b> ELEMENT Tank bottom valve 	<b>Type 3235 ▶</b> Manually operated tank bottom valve 

	Type	Control function	Nominal diameter diaphragm	Diaphragm material	Body material	Port connection	Port connection	Actuator version	Actuator size	Pilot air port	Actuator	Variable	Variable	Variable
Key Feature	TYP	SF	DN	DWST	WKST	LTA1	LTA2	ANTA	ANTG	STLA	ANTR	VAR1	VAR2	VAR3
Key No. →	1	2	3	4	5	6	6	7	8	9	10	V1	V2	V3

2 way diaphragm valve														
<b>Type 2030 CLASSIC</b>	2030	A	20.0	AD	PV	KM26	-	C	E	-	-			
<b>Type 2031 CLASSIC</b>	2031	A	20.0	AD	VS	SA93	-	C	E	-	-	NK52	NO14	
<b>Type 2063 INOX</b>	2063	A	20.0	AD	VS	SA93	-	H	M	-	-	NK52	NO14	
<b>Type 2103 ELEMENT</b>	2103	A	20.0	AD	PV	KM26	-	G	M	FA01	-			
<b>Type 2103 ELEMENT</b>	2103	A	20.0	AD	VS	SA93	-	G	M	FA01	-	NK52	NO14	
<b>Type 3232</b>	3232	-	20.0	AD	PV	KM26	-	-	-	-	D050			
<b>Type 3233</b>	3233	-	20.0	AD	VS	SA93	-	-	-	-	D051	NK52	NO14	
T-diaphragm valve														
<b>Type 2032 CLASSIC</b>	2032	A	20.0	AD	VH	SODH	SA93	D	E	-	-	NK52	NO14	
<b>Type 2064 INOX</b>	2064	A	20.0	AD	VH	SODH	SA93	-	M	-	-	NK52	NO14	
<b>Type 2104 ELEMENT</b>	2104	A	20.0	AD	VH	SODH	SA93	-	M	FA01	-	NK52	NO14	
<b>Type 3234</b>	3234	-	20.0	AD	VH	SODH	SA93	-	-	-	D050	NK52	NO14	
Tank bottom diaphragm valve														
<b>Type 2033 CLASSIC</b>	2033	A	20.0	AD	VH	SA93	-	D	F	-	-	NK52	NO14	
<b>Type 2065 INOX</b>	2065	A	20.0	AD	VH	SA93	-	-	M	-	-	NK52	NO14	
<b>Type 2105 ELEMENT</b>	2105	A	20.0	AD	VH	SA93	-	-	M	FA01	-	NK52	NO14	
<b>Type 3235</b>	3235	-	20.0	AD	VH	SA93	-	-	-	-	D050	NK52	NO14	

1.) NK52, NOxx only for stainless steel bodies

## Key Legend

**Note:**

- Other versions on request
- Available Type sizes see corresponding data sheet

Key no. 2: Control function (SF)				Key no. 8: Actuator size (ANTG)	
A	Closed with spring force			B	ø 32
B	Open with spring force			C	ø 40
I	Without pressure spring			D	ø 50
Key no. 3: Nominal diameter diaphragm (DN)				E	ø 63
8	25	50	100	F	ø 80
15	32	65		G	ø 100
20	40	80		H	ø 125
Key no. 4: Diaphragm material (DWST)				K	ø 175
AD	EPDM			L	ø 225
EA	PTFE/EPDM			M	ø 70
EU	Advanced PTFE/EPDM laminated			N	ø 90
ER	Gylon®/EPDM laminated			P	ø 130
Key no. 5: Body material (WKST)				Key no. 9: Pilot air port (ELEMENT) (STLA)	
PD	PVDF (Polyvinylidene fluoride)			FA01	Pilot air port Push-In 6/4, 1/4"
PP	PP (Polypropylene)			FA02	Pilot air port G1/8
PV	PVC-U (Polyvinyl chloride)			FA03	Interface ELEMENT control
VG	Stainless steel precision casting 1.4435/316L			Key no. 10: Actuator (ANTR)	
VH	Stainless steel block material 1.4435/316L			D050	Handwheel and attachment PPS
VI	Stainless steel block material 1.4435 BN2/316L ASME BPE			D051 <sup>1.)</sup>	Handwheel PPS and attachment St. St.
VP	Stainless steel tube 1.4435 BN2/316L			D052 <sup>2.)</sup>	Handwheel and attachment St. St.
VS	Stainless steel-forged 1.4435 BN2/316L ASME BPE			1.) Alternatively D058	
Key no. 6: Port connection (LTA1, LTA2)				2.) Alternatively D059 or D102	
Listed in detail below				Key no. V1, V2, ...: Variable code (VAR1, VAR2, VAR3)	
Key no. 7: Actuator version (ANTA)				NK52 <sup>3.)</sup>	Acceptance test certificate 3.1 according to EN 10204
C	PA actuator (only CLASSIC)			NO14 <sup>3.)</sup>	Mechanically polished Ra ≤ 0.5 µm (ASME BPE SF1)
D	PPS actuator (only CLASSIC)			NO17 <sup>3.)</sup>	Electropolished Ra ≤ 0.38 µm (ASME BPE SF4 / DIN HE4)
G	ELEMENT design actuator (only ELEMENT)			NO06 <sup>3.)</sup>	Mechanically polished Ra ≤ 0.76 µm (ASME BPE SF3 / DIN H2)
H	St. St. actuator (only INOX)			NO16 <sup>3.)</sup>	Electropolished Ra ≤ 0.6 µm (ASME BPE SF6)
				EC04	Reduced spring force
				3.) NK52, NOxx only for stainless steel bodies	

**Key no. 6: Port connection (LTA)**

Weld connection								
DN [mm]	EN ISO 1127 / ISO 4200 DIN 11866 R. B	SMS 3008	DIN 11850 R. 0	DIN 11850 R. 1	DIN 11850 R. 2 DIN 11866 R. A	DIN 11850 R. 3	BS4825	ASME BPE DIN 11866 R. C
4	-	-	SC40-6.0x1.0	-	-	-	-	-
6	SA78-10.2x1.6	-	SC41-8.0x1.0	-	-	-	-	SA89-3.17x0.56
8	SA40-13.5x1.6	-	SC42-10.0x1.0	-	-	-	SODB-6.35x1.2	SA90-6.35x0.89
10	SA41-17.2x1.6	-	-	SF40-12.0x1.0	SD40-13.0x1.5	SE40-14.0x2.0	SODC-9.53x1.2	SA91-9.53x0.89
15	SA42-21.3x1.6	SA58-12.0x1.0	SC43-18.0x1.5	SF41-18.0x1.0	SD42-19.0x1.5	SE42-20.0x2.0	SODD-12.7x1.2	SA92-12.7x1.65
20	SA43-26.9x1.6	SA59-18.0x1.0	SC44-22.0x1.5	SF42-22.0x1.0	SD43-23.0x1.5	SE43-24.0x2.0	SODE-19.05x1.2	SA93-19.05x1.65
25	SA44-33.7x2.0	SA60-25.0x1.2	SC45-28.0x1.5	SF43-28.0x1.0	SD44-29.0x1.5	SE44-30.0x2.0	-	SODF-25.4x1.65
32	SA45-42.4x2.0	SA61-33.7x1.2	SC46-34.0x1.5	SF44-34.0x1.0	SD45-35.0x1.5	SE45-36.0x2.0	-	-
40	SA46-48.3x2.0	SA62-38.0x1.2	SC47-40.0x1.5	SF45-40.0x1.0	SD46-41.0x1.5	SE46-42.0x2.0	-	SODH-38.1x1.65
50	SA47-60.3x2.0	SA63-51.0x1.2	SC48-52.0x1.5	SF46-52.0x1.0	SD47-53.0x1.5	SE47-54.0x2.0	-	SODI-50.8x1.65
65	SA48-76.1x2.0	SA64-63.5x1.6	-	-	SD48-70.0x2.0	-	-	SODJ-63.5x1.65
80	SA49-88.9x2.3	SA65-76.1x1.6	-	-	SD49-85.0x2.0	-	-	SODK-76.2x1.65
100	SA39-114.3x2.3	SA66-101.6x2.0	-	-	SD50-104.0x2.0	-	-	SODL-101.6x2.11

**Product Enquiry Form**  
**Diaphragm valve with straight**  
**way valve, T-valve or tank bottom**  
**valve**



Clamp connection					
DN [mm]	Clamp 34,0 similar to DIN 32676 R. B (ISO tube (ISO4200))	DIN 32676 R. A (DIN tube (DIN11850))	DIN 32676 R. B (ISO tube (ISO4200))	ASME BPE	BS 4825 (Clamp BS 4825-3, tube BS 4825-1)
8	TC51-13.5×1.6 Cl: 34.0	TD40-10.0×1.0 Cl: 25.0	TC40-13.5×1.6 Cl: 25.0	TG 50-6.35×0.89 Cl: 25.0	-
10	TC41-17.2×1.6 Cl: 34.0	TD41-13.0×1.5 Cl: 34.0	TC53-17.2×1.6 Cl: 25.0	TG 01-9.53×0.89 Cl: 25.0	-
15	TC42-21.3×1.6 Cl: 34.0	TD42-19,0×1.5 Cl: 34.0	TC52-21.3×1.6 Cl: 50.5	TG 02-12.7×1.65 Cl: 25.0	TH42-12.7×1.2 Cl: 25.0
20	-	TD43-23.0×1.5 Cl: 34.0	TC43-26.9×1.6 Cl: 50.5	TG 03-19.05×1.65 Cl: 25.0	TH43-19.05×1.2 Cl: 25.0
25	-	TD44-29.0×1.5 Cl: 50.5	TC44-33.7×2.0 Cl: 50.5	TG 04-25.4×1.65 Cl: 50.5	-
32	-	-	-	-	-
40	-	TD46-41.0×1.5 Cl: 50.5	TC46-48.3×2.0 Cl: 64.0	TG 05-38.1×1.65 Cl: 50.5	-
50	-	TD47-53.0×1.5 Cl: 64.0	TC47-60.3×2.0 Cl: 77.5	TG 06-50.8×1.65 Cl: 64.0	-
65	-	-	TC48-76.1×2.0 Cl: 91.0	TG 07-63.5×1.65 Cl: 77.5	-
80	-	-	TC49-88.9×2.3 Cl: 106.0	TG 08-76.2x,65 Cl: 91.0	-
100	-	-	TC50-114.3×2.3 Cl: 130.0	TG 09-101.6×2.11 Cl: 119.0	-

Plastic connection					
DN [mm]	Welded connection socket (only WKST=PD, PP)	Welded connection threaded socket (only WKST=PD, PP)	Adhesive bond socket (only WKST=PV)	Adhesive bond threaded socket (only WKST=PV)	Loose-type flange (up to DN65) Fixed flange (from DN80)
15	SS25 - ø20	SM25 - ø20	KS25 - ø20	KM25 - ø20	FL24
20	SS26 - ø25	SM26 - ø25	KS26 - ø25	KM26 - ø25	FL25
25	SS27 - ø32	SM27 - ø32	KS27 - ø32	KM27 - ø32	FL26
32	SS28 - ø40	SM28 - ø40	KS28 - ø40	KM28 - ø40	FL27
40	SS29 - ø50	SM29 - ø50	KS29 - ø50	KM29 - ø50	FL28
50	SS30 - ø63	SM30 - ø63	KS30 - ø63	KM30 - ø63	FL29
65	-	-	-	-	FL30
80	-	-	-	-	FF31
100	-	-	-	-	FF32

DTS 1000450599 EN Version: A Status: RL (released | freigegeben | validé) printed: 10.02.2021

## Positioner / process controller TopControl for control valves of the ELEMENT series

For actuator size  $\varnothing 70/\varnothing 90/\varnothing 130$  mm

Process Controller TopControl Type 8693 ▶		Positioner TopControl Type 8692 ▶	
	<ul style="list-style-type: none"> <li>Intelligent digital positioners and process controllers with integrated PID controller for accurate process control</li> <li>Lighted graphic display with membrane keypad</li> <li>Tune function for automatic start-up</li> <li>Field bus communication</li> <li>Diagnostic functions</li> </ul>		<ul style="list-style-type: none"> <li>Digital positioner without sensor input</li> <li>Lighted graphic display with membrane keypad</li> <li>Tune function for automatic start-up</li> <li>Field bus communication</li> <li>Diagnostic functions</li> </ul>
<b>Pneumatic function</b> Single-acting                  Double-acting		<b>Electrical connection</b> Cable gland                          M12 Multipole connection Without	
<b>Digital Communication</b> PROFIBUS DP-V1                  DeviceNet                  EtherNet/IP PROFINET                          Bürkert Systembus (bùS) <sup>1.)</sup> Modbus TCP                          Without		<b>Approvals</b> ATEX cat. 3GD, IECEx                  Without	
<b>Analogue feedback</b> 0/4...20 mA                          0/4...20 mA + 2 binary outputs		<b>Digital outputs and diagnostics</b> Yes    No	

1.) Based on CANopen

For actuator size  $\varnothing 70/\varnothing 90/\varnothing 130$  mm

For actuator size  $\varnothing 50$  mm

Positioner TopControl BASIC Type 8694 ▶		Positioner TopControl BASIC Type 8696 ▶	
	<ul style="list-style-type: none"> <li>Status LED and DIP switches</li> <li>Tune-function for automatic start-up</li> <li>Positioning system for single-acting actuators</li> <li>Field bus communication</li> </ul>		<ul style="list-style-type: none"> <li>Status LED and DIP switches</li> <li>Tune-function for automatic start-up</li> <li>Positioning system for single-acting actuators</li> </ul>
<b>Pneumatic function</b> Single-acting		<b>Electrical connection</b> Cable gland <sup>1.)</sup> M12 Multipole connection Without	
<b>Digital Communication</b> AS-Interface <sup>1.)</sup> IO-Link                  Bürkert Systembus (bùS) <sup>2.)</sup> Without		<b>Approvals</b> ATEX cat. 3GD, IECEx                  Without	
<b>Analogue feedback</b> Yes    No			



1.) Only available for Type 8694. Not available for Type 8696.

2.) Based on CANopen

DTS 1000450599 EN Version: A Status: RL (released | freigegeben | validé) printed: 10.02.2021

## Positioner / process controller SideControl Remote for control valves of the ELEMENT series



For actuator size  $\varnothing 70/\varnothing 90/\varnothing 130$  mm

Process Controller SideControl Type 8793 with Remote sensor Type 8798		Positioner SideControl Type 8792 with Remote sensor Type 8798	
	<ul style="list-style-type: none"> <li>Intelligent digital positioners and process controllers with integrated PID controller</li> <li>Lighted graphic display with membrane keypad</li> <li>Tune-function for automatic start-up, linearization and optimization of process characteristics</li> <li>Field bus communication</li> <li>Diagnostic functions</li> </ul>		<ul style="list-style-type: none"> <li>Digital positioner without sensor input</li> <li>Lighted graphic display with membrane keypad</li> <li>Tune function for automatic start-up</li> <li>Field bus communication</li> <li>Diagnostic functions</li> </ul>
<b>Pneumatic function</b>		<b>Electrical connection</b>	
Single-acting	Single- and double-acting	Cable gland <sup>1.)</sup>	M12 Multipole connection
<b>Digital communication</b>		<b>Approvals</b>	
PROFIBUS DP-V1	DeviceNet	EtherNet/IP	ATEX cat. 3GD, IECEx
PROFINET	Bürkert Systembus (bÜS) <sup>2.)</sup>		Without
Modbus TCP	Without		
<b>Analogue feedback</b>		<b>Digital outputs and diagnostics</b>	
0/4...20 mA	0/4...20 mA + 2 binary outputs	Yes	No
0/5...10 V	0/5...20 V + 2 binary outputs		

1.) With a cable gland the selection of a fieldbus communication PROFIBUS, EtherNet etc. is not possible. Only variants with M12 Multipole are offered as standard for fieldbus communication.

2.) Based on CANopen

For actuator size  $\varnothing 70/\varnothing 90/\varnothing 130$  mm

Positioner SideControl BASIC Type 8791 with Remote sensor Type 8798		Positioner SideControl BASIC IP20 Type 8791 with Remote sensor Type 8798	
	<ul style="list-style-type: none"> <li>„simple positioner“</li> <li>Universal positioning system for single and double acting actuators</li> <li>Tune function for automatic start-up</li> <li>Field bus communication</li> </ul>		<ul style="list-style-type: none"> <li>„simple positioner“</li> <li>Universal positioning system for single and double acting actuators</li> <li>Tune function for automatic start-up</li> <li>Switchgear cabinet assembly</li> </ul>
<b>Pneumatic function</b>		<b>Electrical connection</b>	
Single-acting (actuator size $\varnothing 70/90$ )	Single- and double-acting (actuator size $\varnothing 130$ )	Cable gland <sup>1.)</sup>	M12 Multipole connection
<b>Digital communication</b>		<b>Approvals</b>	
AS-Interface <sup>2.)</sup> :		ATEX cat. 3GD, IECEx <sup>2.)</sup>	Without
Analogue profile S-7.3.4 (only set point)			
Analogue profile S-7.A.5 (set point and feedback)			
IO-Link	Bürkert Systembus (bÜS) <sup>3.)</sup>	Without	
<b>Analogue feedback</b>			
0/4...20 mA	No		



1.) With a cable gland, the selection of a fieldbus communication AS-Interface is not possible. For fieldbus communication, only variants with M12 Multipole are offered as standard.

2.) Only available for Positioner SideControl BASIC Type 8791. Not available for Positioner SideControl BASIC IP20 Type 8791.

3.) Based on CANopen, IO-Link and bÜS not available for IP20 Type 8791

DTS 1000450599 EN Version: A Status: RL (released | freigegeben | validé) printed: 10.02.2021

## Control heads / pneumatic control for on/off process valves of the ELEMENT series

For actuator size $\varnothing 70/\varnothing 90/\varnothing 130$ mm			For actuator size $\varnothing 50$ mm	
Control head Type 8691 ▶			Control head Type 8695 ▶	
				
<ul style="list-style-type: none"> <li>Inductive position sensor with automatic Teach function</li> <li>Coloured high power LEDs</li> <li>With/without pilot valve for single or double-acting actuators</li> <li>Fieldbus communication</li> <li>Hygienic stainless steel design</li> </ul>				
<b>Pneumatic function</b>			<b>Electrical connection</b>	
Single-acting	Double-acting	Without pilot valve	Cable gland	M12 connector
<b>Communication</b>			<b>Approvals</b>	
AS-Interface	DeviceNet	IO-Link	ATEX cat. 3GD, IECEx	Without
Bürkert Systembus (büS) <sup>1.)</sup>			Without	

1.) Based on CANopen

For actuator size $\varnothing 70/\varnothing 90/\varnothing 130$ mm			For actuator size $\varnothing 50$ mm	
Pneumatic control unit / feedback Type 8690 ▶			Pneumatic control unit / feedback Type 8697 ▶	
				
<ul style="list-style-type: none"> <li>Visual status indicator</li> <li>Micro- or proximity switches for end position feedback</li> <li>With/without pilot valve for single- or double-acting actuators</li> <li>Optional intrinsically safe version acc. to ATEX / IECEx</li> </ul>				
<b>Pneumatic function</b>			<b>Electrical connection</b>	
Single-acting	Double-acting (Type 8690)		Cable gland	M12 connector
Without pilot valve				
<b>Number of position feedback switches</b>			<b>Approvals</b>	
1x	2x		ATEX cat. 3GD, IECEx	ATEX cat. 2DG, IECEx
			Without	
<b>Position feedback switch</b>				
Micro-switch 24 V DC		Micro-switch 50...225 V DC/AC (Type 8690)	Inductive switch 3-wire PNP	
Inductive switch 2-wire NAMUR		Inductive switch 2-wire 24 V DC	Without	

DTS 1000450599 EN Version: A Status: RL (released | freigegeben | valide) printed: 10.02.2021